

SUITE MIRROR

PRODUCT SPECIFICATION

KISTIA

FRONT-LIT MIRROR

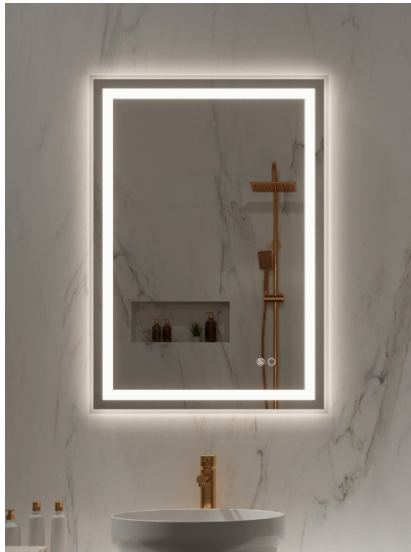

FEATURES

- LED technology
- 3-in-1 adjustable color modes - 3000K, 4000K & 6000K
- Dimmable using touch button
- Anti-fog
- CRI 90+
- ETL certified
- 110V hard-wired electrical connection
- Vertical and horizontal mount
- 1 year warranty

SAFETY SPECIFICATION

- Entire assembly meets ETL Canada & US standards
- Safety-backed mirror

Part Number	Kelvin Temperature	Lumens	Power Rating	Dimensions	Weight	IP Rating
KISTX2432CCT-TS	3000K/4000K/6000K	2448lm	110V, 60.4W	24" x 36" x 1 5/8"	18.60 lbs	IP44
KISTX4032CCT-TS	3000K/4000K/6000K	3264lm	110V, 68.9W	40" x 36" x 1 5/8"	31.00 lbs	IP44
KISTX4832CCT-TS	3000K/4000K/6000K	3648lm	110V, 72.9W	48" x 36" x 1 5/8"	37.20 lbs	IP44
KISTX6032CCT-TS	3000K/4000K/6000K	4224lm	110V, 101.75W	60" x 36" x 1 5/8"	46.50 lbs	IP44

HOW TO USE THE TOUCH BUTTONS



Left Touch Button – Anti-fog

- Tap the touch button to turn the anti-fog ON and OFF.
- ❖ The mirror is equipped with a safety feature that automatically shut offs the anti-fog after an hour.



Right Touch Button – ON/OFF, Color Change & Dimming

- Tap the touch button to turn the light ON and OFF.
- Quick-double-tap to change the light temperature from 3000K to 4000K to 6000K.
- Press and hold the sensor button to dim the light.
- ❖ The mirror is equipped with a memory feature to preserve the previous brightness setting.

SUITE MIRROR

PRODUCT SPECIFICATION

KISTIA

FRONT-LIT MIRROR

KISTX2432CCT-TS

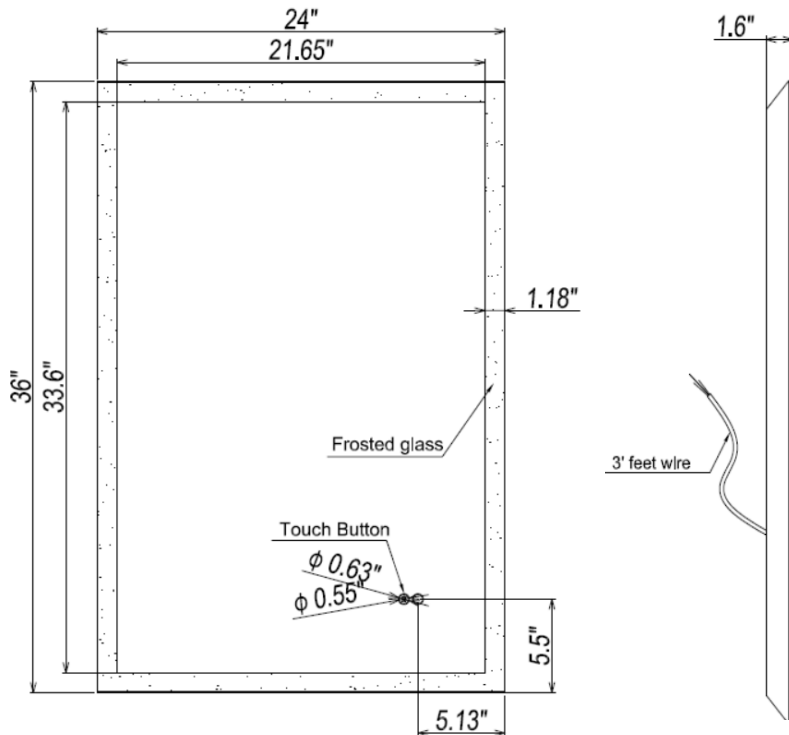

FRONT VIEW

LEFT VIEW

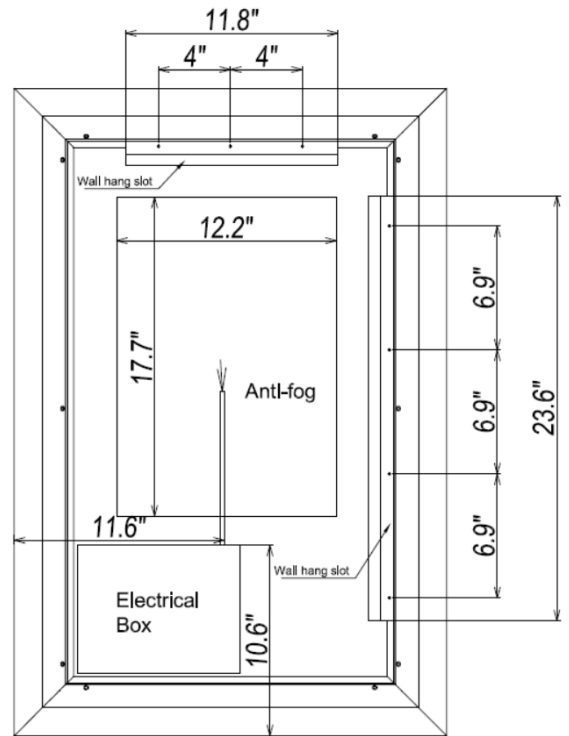

REAR VIEW

KISTX4032CCT-TS

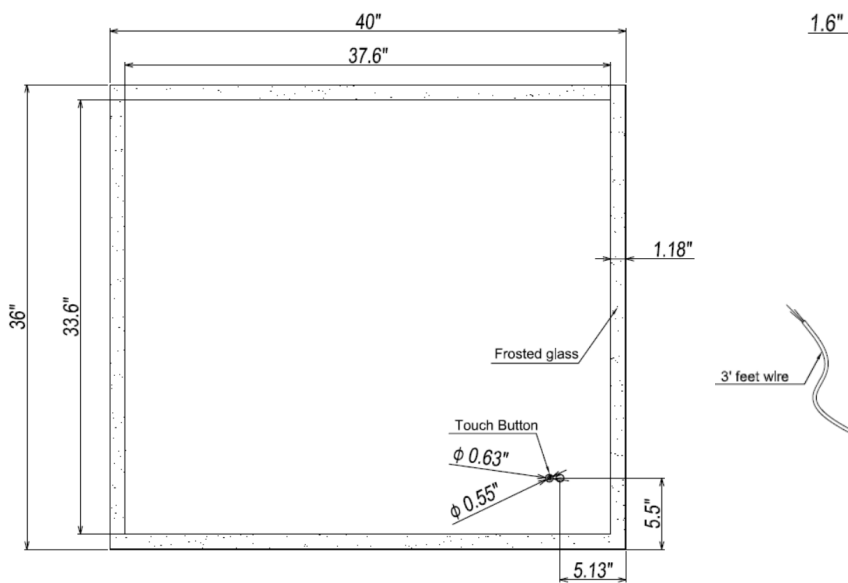

FRONT VIEW

LEFT VIEW

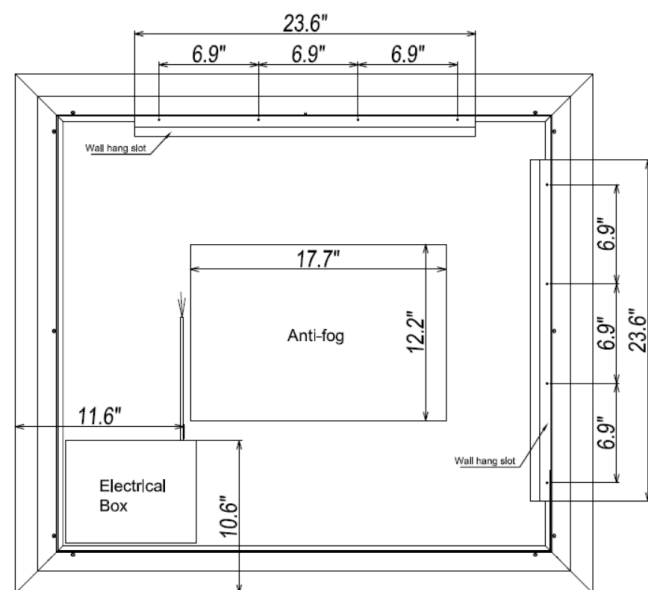

REAR VIEW

SUITE MIRROR

PRODUCT SPECIFICATION

KISTIA

FRONT-LIT MIRROR

KISTX4832CCT-TS

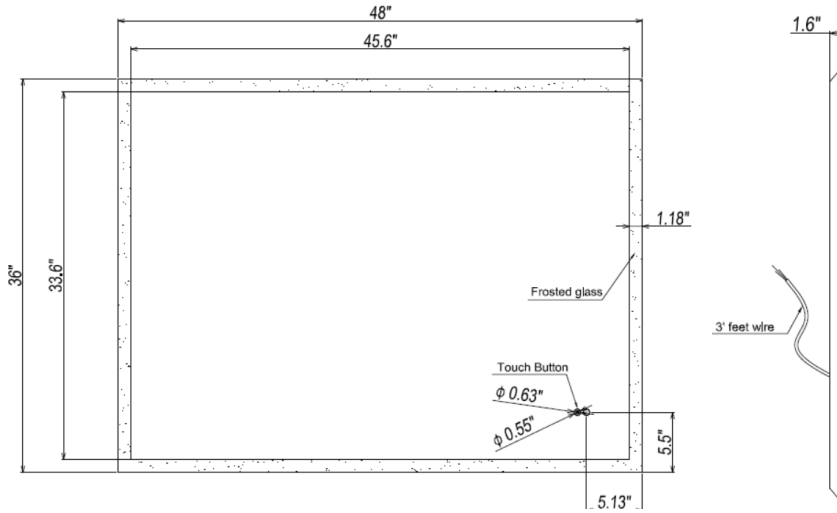

FRONT VIEW

LEFT VIEW

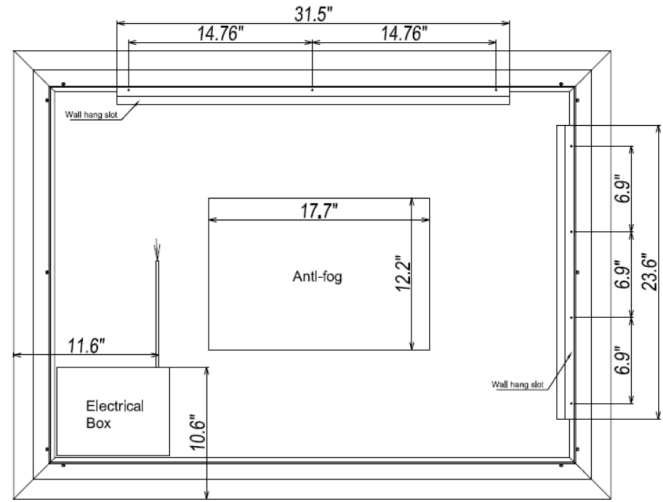

REAR VIEW

KISTX6032CCT-TS

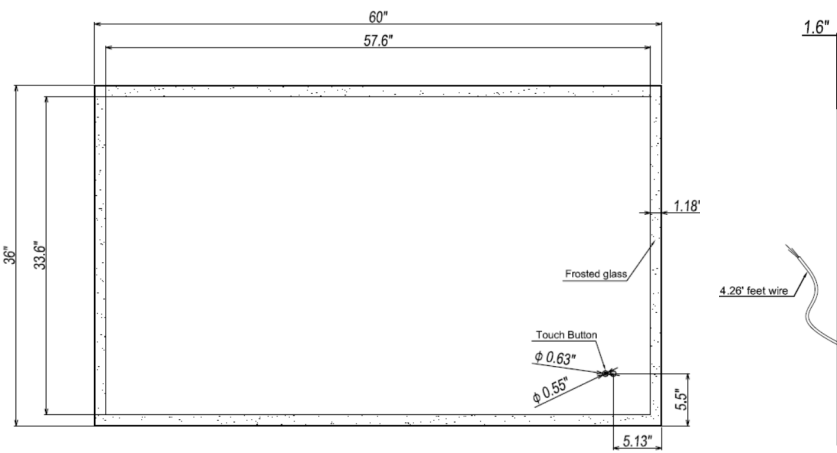

FRONT VIEW

LEFT VIEW

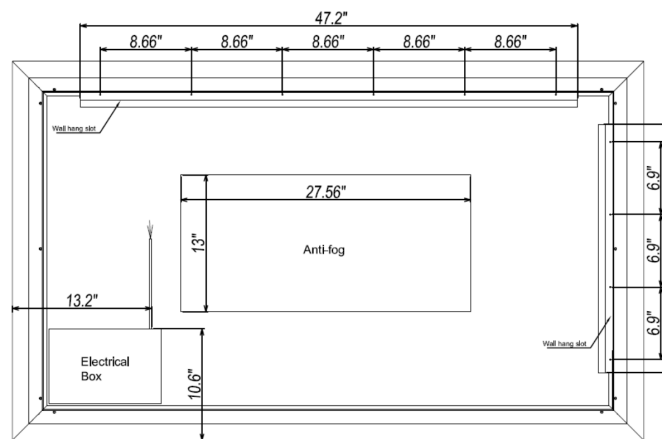

REAR VIEW

INSTALLATION & AFTER CARE INSTRUCTIONS:

Electrical and Safety Specifications:

- 110V hard-wired electrical connection.
- Mirror can be turned ON/OFF and dimmed using the integrated touch button.
- All front-lit and backlit mirrors have been independently tested for compliance with electrical equipment (safety) regulations.
- All front-lit and backlit mirrors are IP44 rated.
- Illuminated mirrors have been designed and independently tested for compliance to electrical equipment (safety) regulations, and are ETL Canada & US Certified.
- LEDs have a life expectancy of 120,000 hours of continuous use.

Installation

- Decide on wall positional placement.
- Prepare & install wall hooks measured to distance between mirror's anchors.
- Match & attach 3 electrical wires from mirror to home electrical wires:
 - Live to Live, Ground to Ground, Neutral to Neutral.
- Hang and affix to wall.

IMPORTANT: Always switch off the electrical supply at the mains during installation and maintenance. It is recommended that fuse is withdrawn or circuit breaker switched off before installation begins. Fitting in Bathrooms is subject to all regulations. It is not suitable for product installations in saunas, steam rooms, or shower cubicles, and it is recommended for permanent installation.

Care & Safety:

- Wear suitable eye wear protection when drilling. Use caution when using power tools near water, beware of hidden cables or pipes.
- Be cautious if drilling on tiled surfaces in case the drill slips. Applying a piece of masking tape on the wall before marking out fixing holes can help stopping the drill from moving.

Cleaning & Maintenance:

- It is recommended that the unit is cleaned with a soft, dry, non-abrasive cloth when turned off.
- Never use cleaning agents or abrasive material on any type of surface finish.
- Do not strike glass components with hard or pointy items.
- Do not place very hot or cold items against or in close proximity to glass surfaces.